

NOTICE DE MONTAGE
ASSEMBLING INSTRUCTION
 INSTRUZIONI DI MONTAGGIO
MONTAGEANLEITUNG
 INSTRUCOES DE MONTAGEM
MANUAL DE MONTAJE
 INSTRUKCJE MONTAŻU

Lusso Vittore [A+B+C+D+E]

AVANT DE COMMENCER, SE
 REPORTER AUX CONSEILS
 DE MONTAGE EN ANNEXE

ANTES DE
 COMERCAR, ADRIASE AOS
 CONSELHOS DE
 MONTAGEM EM ANEXO

BEFORE STARTING, REFER
 TO THE ASSEMBLING ADVICE
 IN ANNEX

ANTES DE EMPEZAR
 CONSULTE LOS CONSEJOS
 PARA EL MONTAJE

AVANTI DI COMMINCIARE,
 RIPIRTAGE AGLI CONSIGLI DI
 MONTAGIO

PRZED ROZPOCZECIEM
 ZAPOZNAĆ SIĘ Z ZAŁĄCZONĄ
 INSTRUKCJĄ MONTAŻU

VOR DIE MONTAGE, BITTE
 BEILIEGENDE ANWEISUNGEN
 FOLGEN

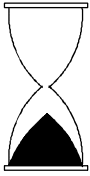

60 min

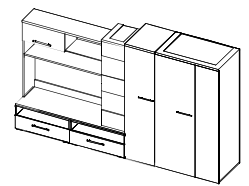
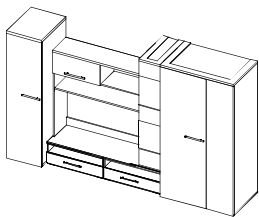
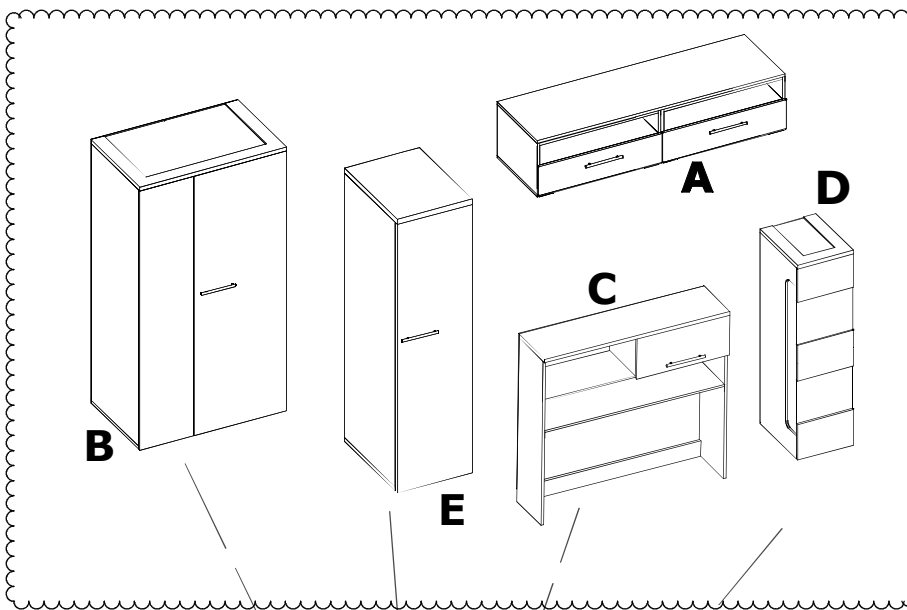
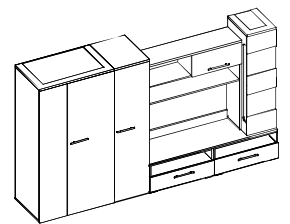
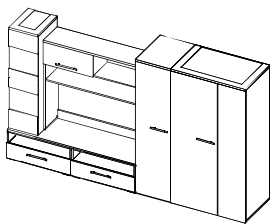
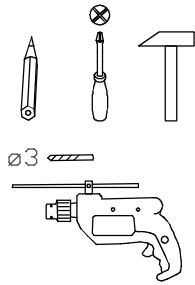
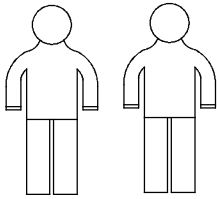

4x

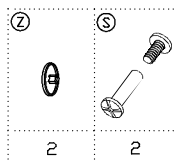

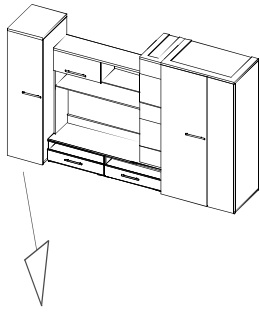

②	③
8	8

