

NOTICE DE MONTAGE
ASSEMBLING INSTRUCTION
 INSTRUZIONI DI MONTAGGIO
MONTAGEANLEITUNG
 INSTRUÇÕES DE MONTAGEM
MANUAL DE MONTAJE
 INSTRUKCJE MONTAŻU

SN-11

AVANT DE COMMENCER, SE
 REPORTER AUX CONSEILS
 DE MONTAGE EN ANNEXE

ANTES DE
 COMERCAR, ADRIASE AOS
 CONSELHOS DE
 MONTAGEM EM ANEXO

BEFORE STARTING, REFER
 TO THE ASSEMBLING ADVICE
 IN ANNEX

ANTES DE EMPEZAR
 CONSULTE LOS CONSEJOS
 PARA EL MONTAJE

AVANTI DI COMMINCIARE,
 RIPORTAGE AGLI CONSIGLI DI
 MONTAGIO

PRZED ROZPOCZECIEM
 ZAPOZNAĆ SIĘ Z ZAŁĄCZONĄ
 INSTRUKCJĄ MONTAŻU

VOR DIE MONTAGE, BITTE
 BEILIEGENDE ANWEISUNGEN
 FOLGEN

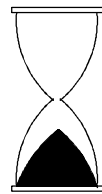
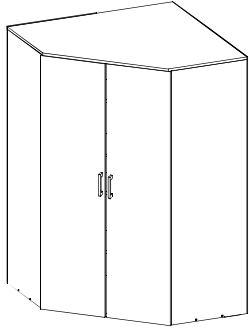

60 min

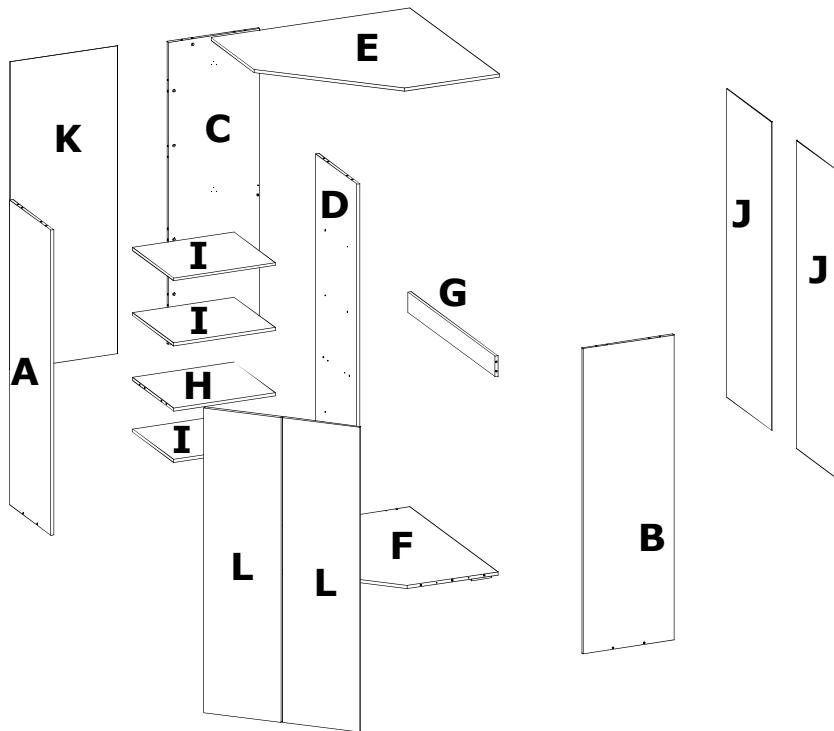
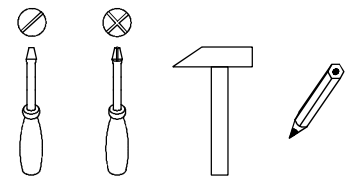
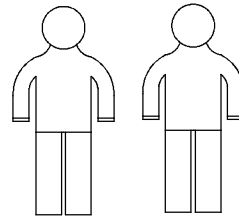

21	28	21	21	4 7x50	6	2	24 3,5x16	80 2x30	24 4x25	4
2	6	6	1	12	1					

1

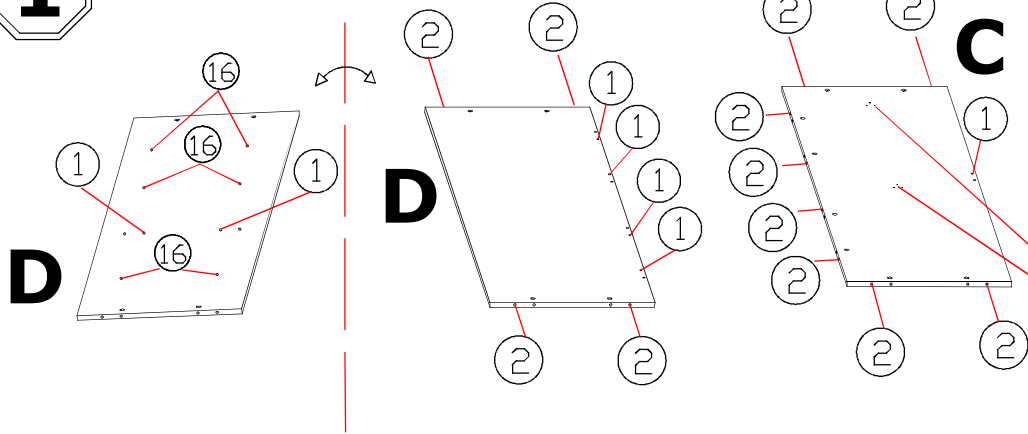

⑧	⑫	①	②	⑮
3,5x16				
6	2	7	12	12

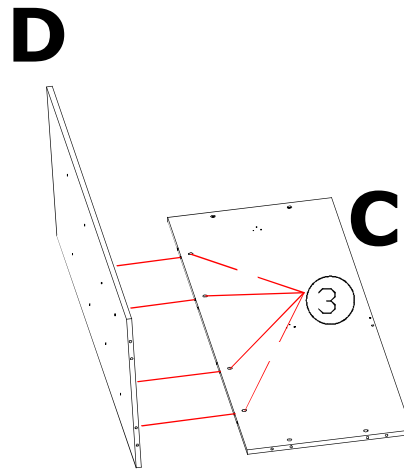
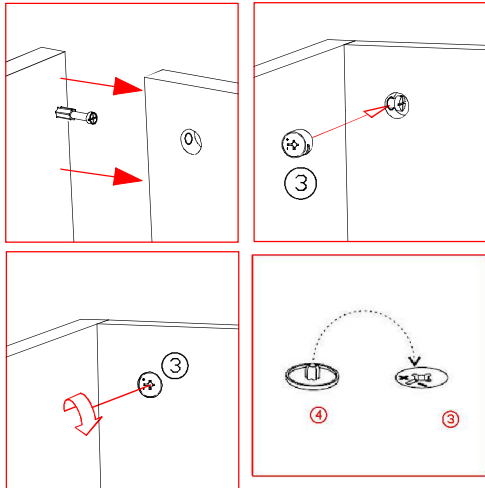
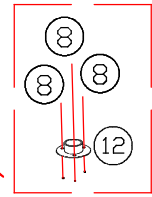

③	④
4	4

2

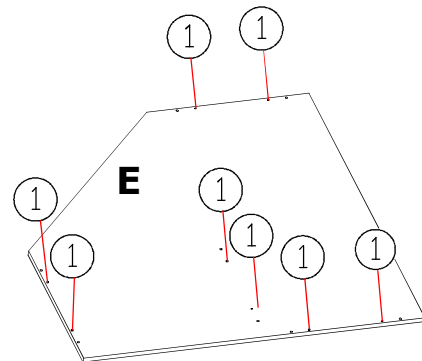
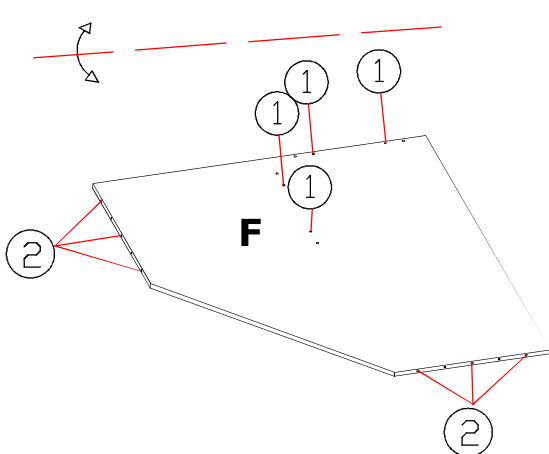
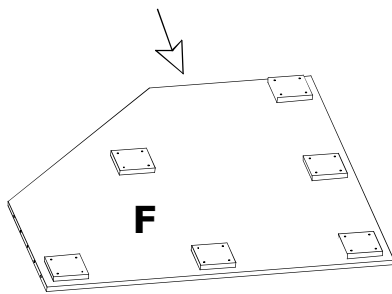
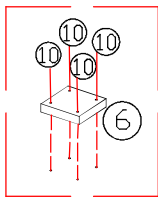

①	②	⑩	⑥
		4x30	
12	6	24	6

3

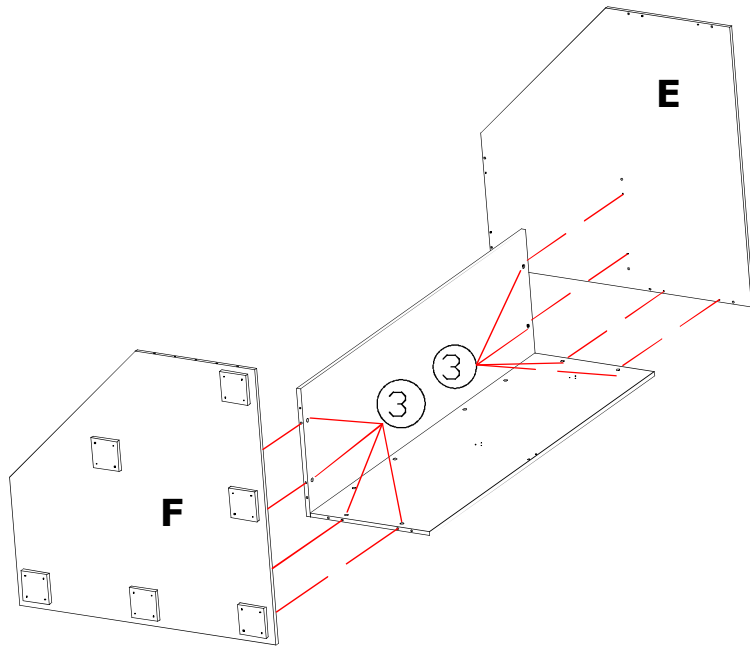

③	④
8	8

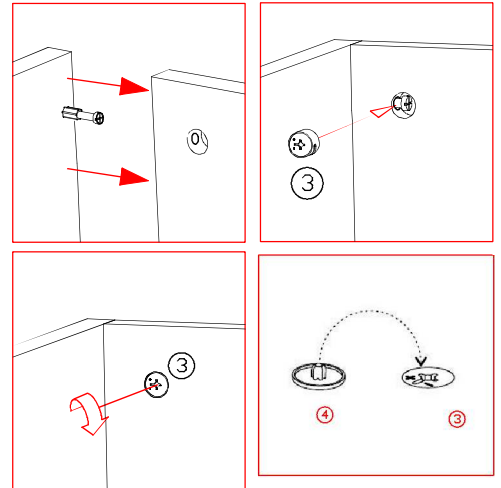

4

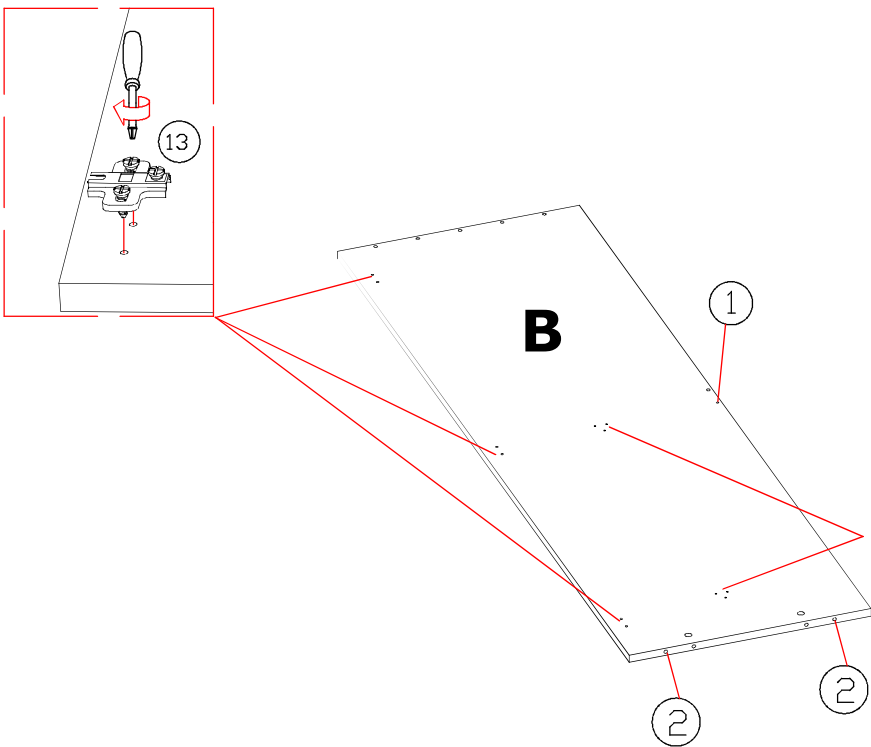

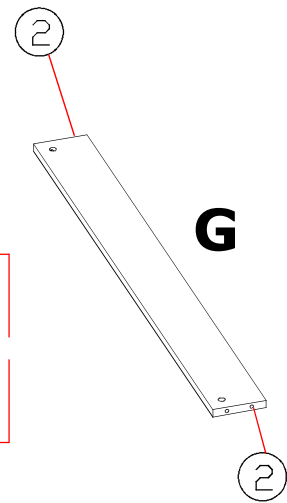
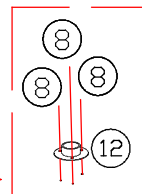

⑬	⑧	⑫	①	②
3	6	2	1	4

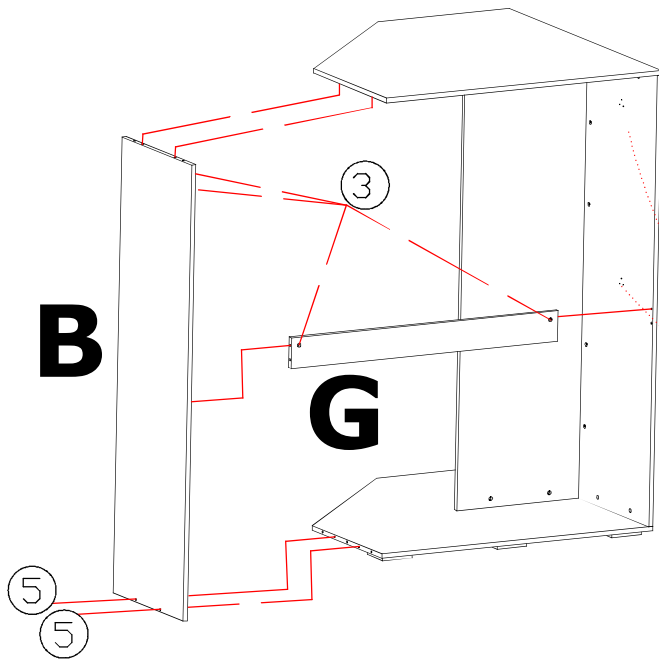

5

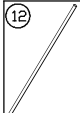
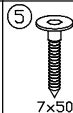

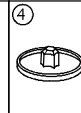

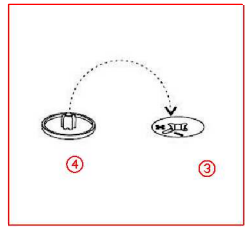
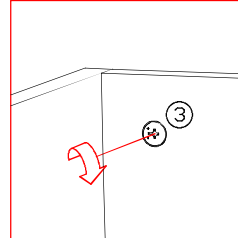
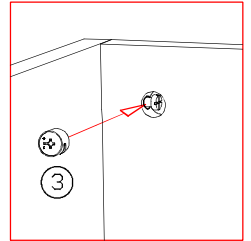
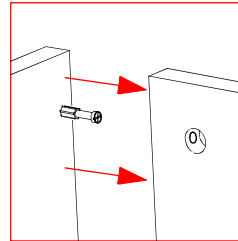
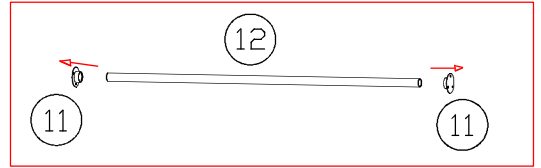
			
1	2	4	4



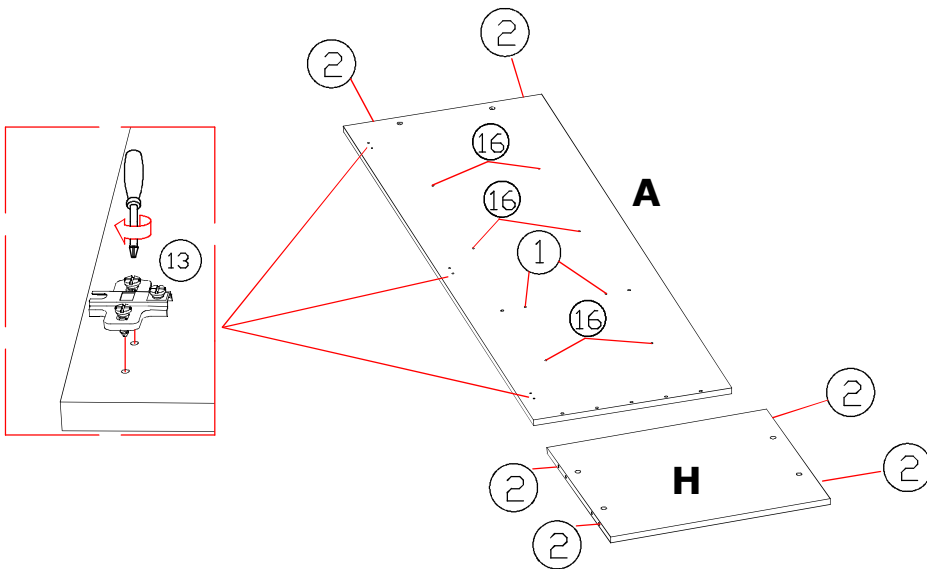

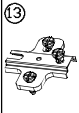
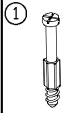
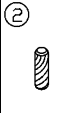
6



			
3	2	6	12

8

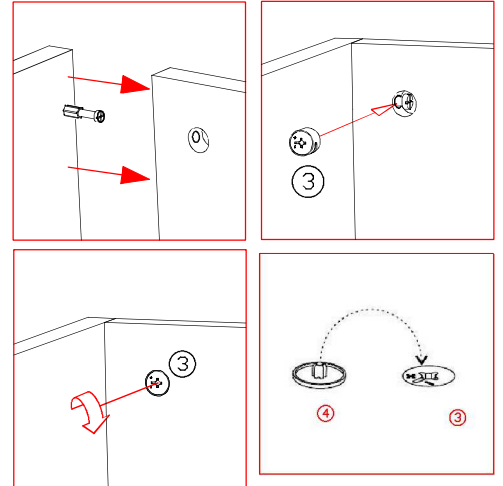
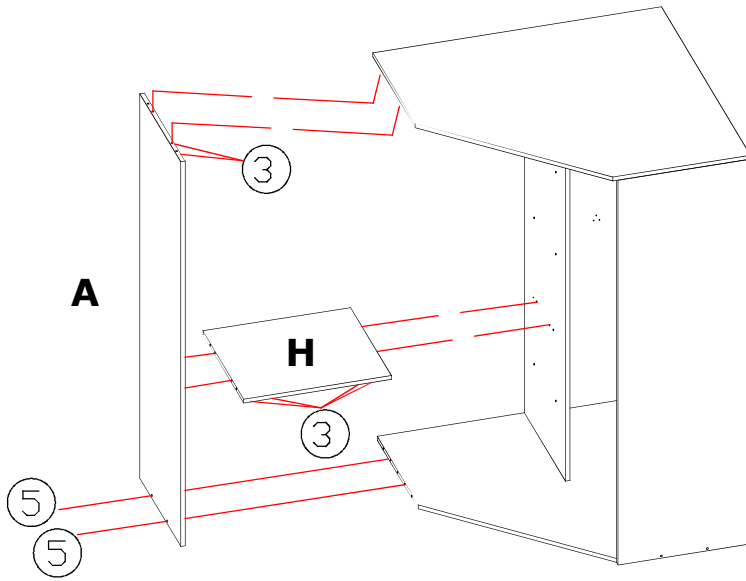

5	3	4
 7x50		
2	6	6

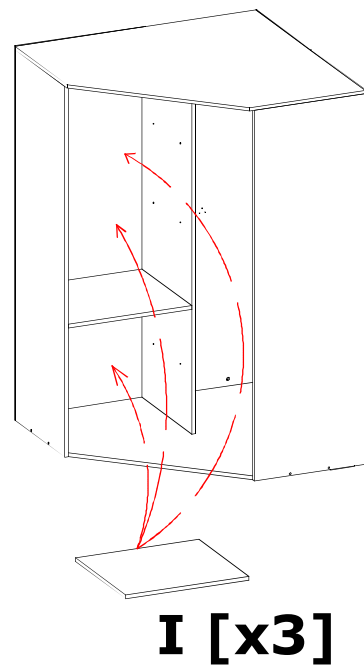
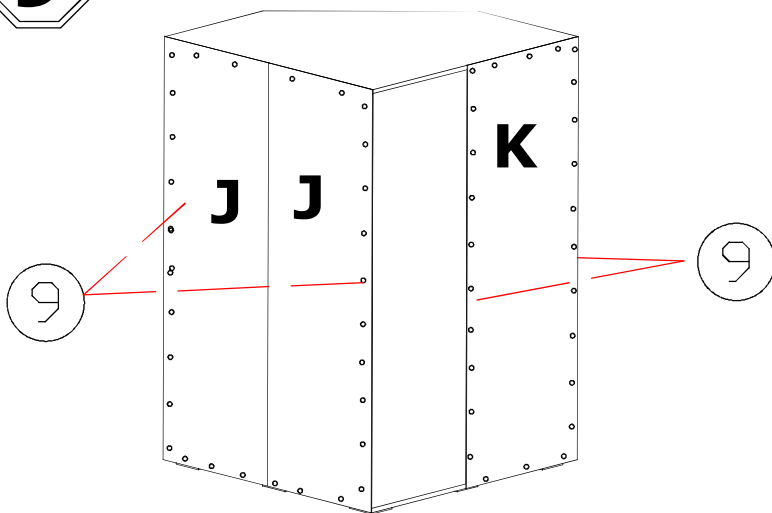

9

9
2x30
70

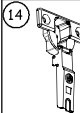

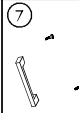
		
6	3,5x16 12	3

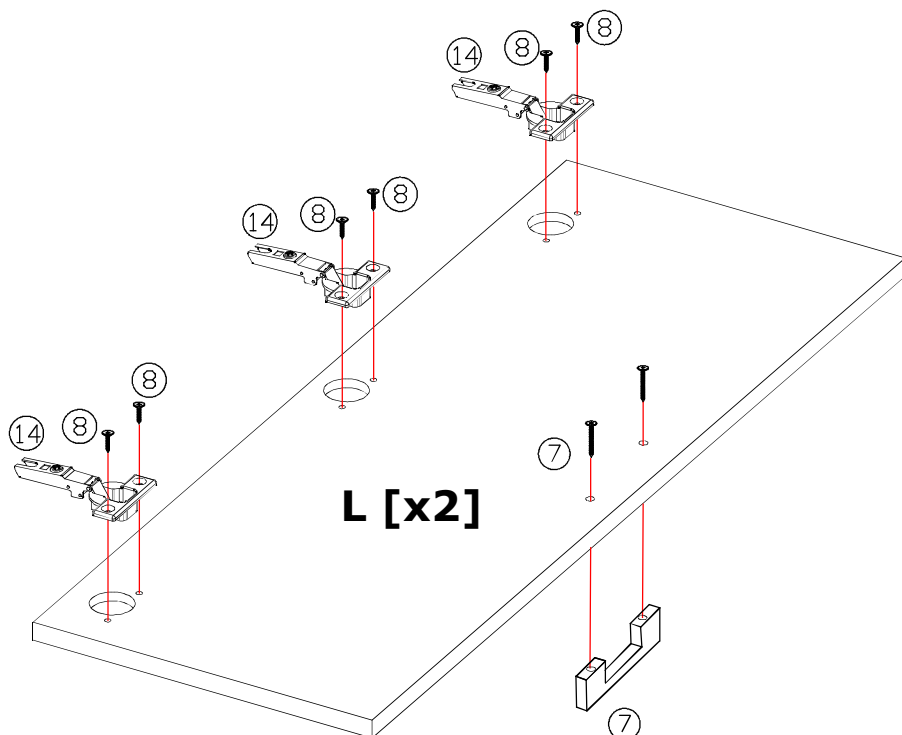

11

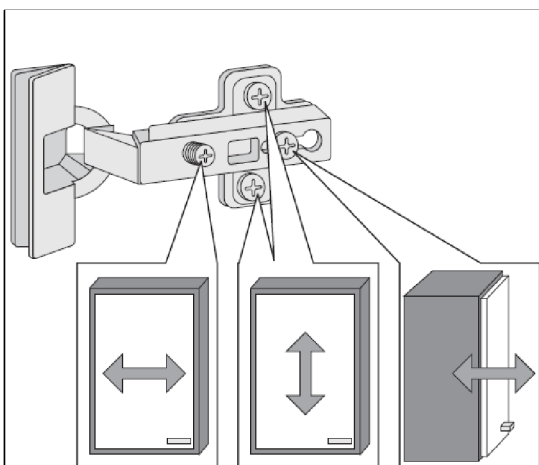
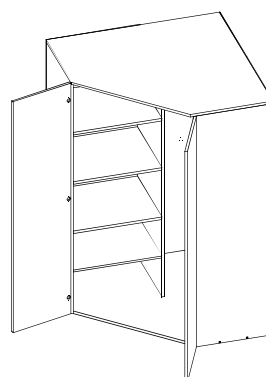
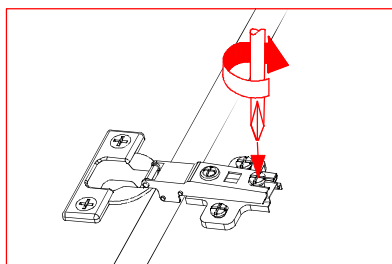
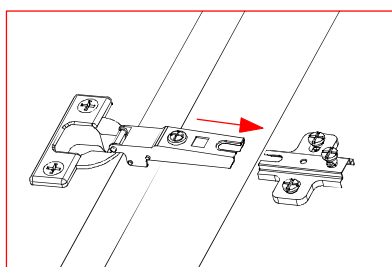

Türen einstellen (Scharniere justieren)
Adjusting the doors (adjusting the hinges)
Régler les portes (ajuster les charnières)
Sistemare le porte (regolare le cerniere)
Deuren instellen (scharnieren afstellen)
Nastawić drzwi (wyregulować zawiasy)
Vyrovnejte dvířka (seřid'te závěsy)
Nastavenie dverí (nastavenie závesov)
Állítsa be az ajtókat (állítsa be a zsanérokat)
Reglare uși (ajustare balamale)
Kapıların ayarlanması (menteşelerin seviye ayarı)
Регулировка дверей (регулировка шарнира)